

### 104 低压电机 104 Low Gear Motor

# 400W □ 104mm



### 电机性能参数 Motor Performance Parameters

型号 Model	电压 Voltage V	空载电流 No-load Current A	空载转速 No-load Speed RPM	额定功率 Rated Power W	额定电流 Rated Current A	额定转速 Rated Speed RPM	额定力矩 Rated Torque N.m	防护等级 Grade Protection IP
G6BLD400-48GN-30S	48	1.50	3800	400	10.5	3000	1.27	44

- 电机电压、功率及转速可在配件尺寸等条件允许下根据客户要求定制。  
Motor voltage, power and speed will be customized according to his requestment under the allowed circumstance of adoptable dimension.

### 种类 Type

#### • 电动机 Motor

机型 Type	型号 Model	
	齿轮轴型 Pinion Shaft	圆轴型 Round Shaft
导线型 Lead Wire Type	G6BLD400-48GN-30S	G6BLD400-48A1-30S
	-	-
	-	-

#### • 平行轴减速器 (另售) Parallel Shaft Gearhead (Sold Separately)

减速机种类 Gearhead Type	减速器型号 Gearhead Model	减速比 Gear Ratio
长寿命、低噪音 Long Life, Low Noise	6GU □ K	3, 3.6, 5, 6, 7.5, 9, 12.5, 15, 18, 25, 30, 36, 50, 60, 75, 90, 100, 120, 150, 180, 200
	6GU10XK(中间减速器 Decimal Gearhead)	

减速器型号的□中为减速比的数值  
Enter the gear ratio in the box ( □ ) within the model name.

### 装有减速器时的容许转矩 Allowable Torque When Being With Gearhead

- 减速器、中间减速器另售
- 减速器型号的□中为减速比的数值
- ■表示与电动机同一方向运转，其它则为相反方向。
- 转速是以电动机的额定转速为基准除以减速比而算出来的数值。实际转速将随负载大小变化而比所示数值减少 2%~20% 左右。
- 希望以大于下表的减速比进行进一步减速时，可在电动机与减速器之间安装减速比为 10 的中间减速器。这时的容许转矩为 20N·m
- Gearhead and mid-gearbox can be sold separately.
- Enter the gear ratio in the box ( □ ) within the model name.
- ■ Indicates the same rotating direction of the motor while the others rotate in the opposite direction.
- The speed is calculated by dividing the motor's synchronous speed by the gear ratio. The actual speed is 2%~20% less than the displayed value, depending on the size of the load.
- To reduce the speed beyond the gear ratio in the table, attach a mid-gearbox (gear ratio:10) between the gearhead and motor. In that case, the permissible torque is 20N·m.

### 容许力矩单位 Allowance Torque Unit: 上段 Upside (N·m) / 下段 Belowside (kgf·cm)

减速比 Gear Ratio	3	3.6	5	6	7.5	9	12.5	15	18	25	30	36	50	60	75	90	100	120	150	180	200
输出轴转速 r/min Output shaft speed	1000	830	600	500	400	330	240	200	166	120	100	83	60	50	40	33	30	25	20	16	15
GU 允许力矩 N·m Allowance torque	3.09	3.71	5.16	6.17	7.74	9.28	11.62	13.94	16.73	21.0	25.2	30.3	40.0	40.0	40.0	40.0	40.0	40.0	40.0	40.0	40.0

# 无刷直流减速电机

## DC BRUSHLESS GEAR MOTOR

### 104 低压电机 104 Low Gear Motor

#### 容许悬挂负载·容许轴向负载 Permissible Overhung Load and Thrust Load

电动机 (圆轴型) → 28 页 Motor (Round Shaft) → P28

减速器 → 28 页 Gearhead → P28

#### 减速器的容许负载惯性量 J Permissible Load Inertia J for Gearhead

→ 28 页 → P28

#### 外形图 (单位 mm) Dimensions (Unit mm)

减速器附有安装用螺丝 Mounting screws are included with gearhead.

##### • 导线型 Lead Wire Type

重量 Weight: 电动机 Motor: 2.5kg 减速器 Gearhead: 2.1kg

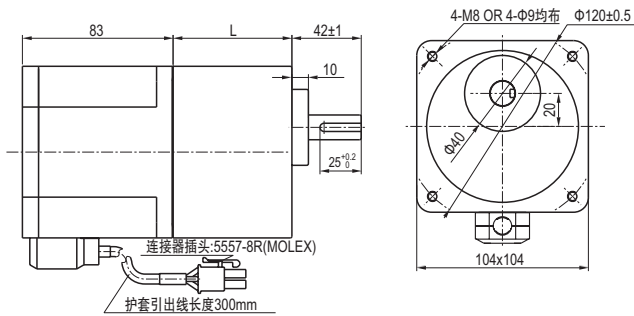

电动机型号 Motor Model	减速器型号 Gearhead type	减速比 Gear Ratio	L 尺寸 Dimension
G6BLD400-48GN-30S	6GU □ K	2~20	65
		25~500	65

减速器型号的□中为减速比的数值

Enter the gear ratio in the box (□) within the model name.

##### • 圆轴型的转轴部分 Shaft Section of Round Shaft Type

除重量及轴部外电动机外形与齿轮轴型相同。

Excluding weight and the shaft section motor shape are the same as those of the pinion shaft type.

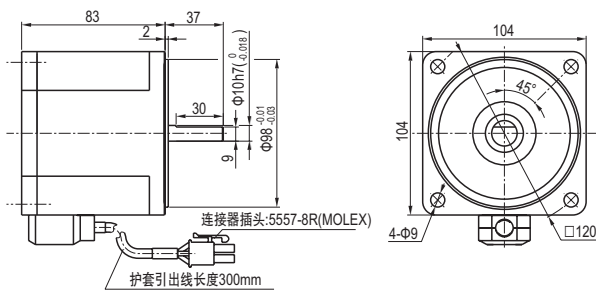

##### • 接线插孔对应信号说明 Wire plughole corresponding signal explanation

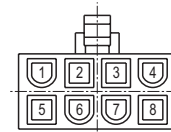

排线对应的意义									
1	2	3	4	5	6	7	8	9	10
蓝 (粗)	白 (细)	黄 (粗)	黄 (细)	白 (粗)	蓝 (细)		金属 丝网	红 (细)	黑 (细)
W	Hu	U	Hv	V	Hw			Vcc+5V	GND

##### • 键·键槽 (减速器附件)

Key · Keyway (The Key Is Included With The Gearhead)

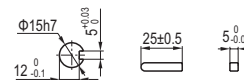

### 104 低压 L 型减速器 104 Low Pressure L Type Reducer

#### 外形图 (单位 mm) Dimensions(Unit mm)

减速器附有安装用螺丝 Mounting screws are included with gearhead.

#### • 导线型 Lead Wire Type

重量 Weight: 电动机 Motor: 4.1kg 减速器 Gearhead: 2.1kg

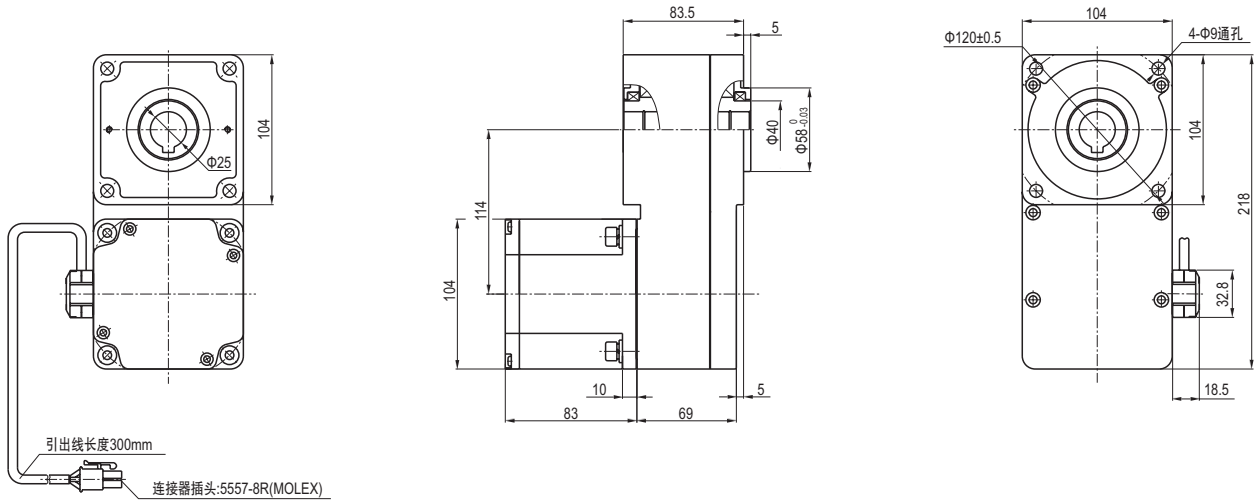

#### • 键·键槽 (减速器附件)

Key · Keyway (The Key Is Included With The Gearhead)

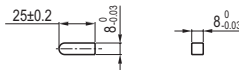

#### • 接线插孔对应信号说明

Wire plughole corresp-onding signal explanation

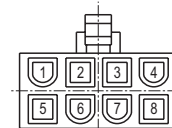

排线对应的意义									
1	2	3	4	5	6	7	8	9	10
蓝 (粗)	白 (细)	黄 (粗)	黄 (细)	白 (粗)	蓝 (细)		金属 丝网	红 (细)	黑 (细)
W	Hu	U	Hv	V	Hw			Vcc+5VV	GND